

SPECIFICATION

MODEL : SLSRGBW815TSNSWS

[Approved Rank : $V_F(S)$, CIE(A3, A4, C1, C2, C3, C4), $I_V(S)$]

RGBW LED

CUSTOMER :

SAMSUNG ELECTRO-MECHANICS CO, .LTD.

314. MAETAN3-DONG, YEONGTONG-KU,
SUWON-SI, GYUNGKI-DO, KOREA, 442-743

Contents

1. Product outline-----	3
2. Absolute Maximum Rating-----	3
3. Characteristics -----	3
4. Chromaticity Diagram -----	5
5. Typical Characteristic Graph -----	6
6. Outline Drawing and Dimension -----	7
7. Reliability Test Items and Conditions ---	8
8. Solder Conditions -----	9
9. Taping Dimension -----	10
10. Label Structure -----	11
11. Lot Number -----	11
12. Reel Packing Structure -----	12
13. Aluminum Vinyl Bag-----	13
14. Precaution for Use -----	14
15. Hazard Substance Analysis-----	16
16. Revision History -----	19

1. Product Outline

1) Feature

- . Lead Frame Type LED Package (5.2 * 6.0 * t 1.3mm)
- . Beam Angle ($\Delta\theta$: 120 °)
- . AlGaInP, GaN/Al₂O₃ Chip & Long Time Reliability

2) Applications

- . Indoor, Outdoor Display and etc.

2. Absolute Maximum Rating

Item	Symbol	Absolute Maximum Rating			Unit
		Red	Green	Blue	
Forward Current	I _F	30	30	30	mA
Pulse Forward Current	I _{FP}	100	100	100	mA
Reverse Voltage	V _r	10	-	-	V
Reverse Current	I _R	-	85	85	mA
Operating Temperature	T _{opr}	-30 ~ 85			°C
Storage Temperature Range	T _{stg}	-40 ~ 100			°C

-. I_{FP} Conditions : Duty 1/10 Pulse Width 10msec

3. Characteristics

Electrical properties

(Ta : 25°C)

Item	Symbol	Condition	Rank	Color	Min.	Typ.	Max.	Unit
Forward Voltage (*)	V _F	I _F = 20 mA	S	Red	1.8	2.1	2.6	V
				Green	2.9	3.2	3.7	
				Blue	2.9	3.2	3.6	
Reverse Current	I _R	V _R = 5V	-	R	-	-	100	μA
Reverse Voltage	V _r	I _R = 10mA	-	G, B	0.6	-	2.0	V

Dominant Wavelength

(Ta : 25°C)

Item	Symbol	Condition	Rank	Color			Unit
				Red	Green	Blue	
Dominant Wavelength (*)	λ _D	I _F = 20 mA	-	618 ~ 628	520 ~ 540	458 ~ 475	nm

Chromaticity Coordinate

(Ta : 25°C)

Item	Condition	Rank	x				y				
Chromaticity Coordinate	IF=60mA (R, G, B IF=20mA)	W	A3	0.220	0.250	0.250	0.220	0.275	0.280	0.245	0.240
			A4	0.250	0.280	0.280	0.250	0.280	0.285	0.250	0.245
			C1	0.220	0.250	0.250	0.220	0.240	0.245	0.210	0.205
			C2	0.250	0.280	0.280	0.250	0.245	0.250	0.215	0.210
			C3	0.220	0.250	0.250	0.220	0.205	0.210	0.175	0.170
			C4	0.250	0.280	0.280	0.250	0.210	0.215	0.180	0.175

Luminous Intensity

(Ta : 25°C)

Item	Symbol	Condition	Rank	Color	min.	typ.	MAX.	Unit
Luminous Intensity (*)	I_v	$I_F = 20 \text{ mA}$	S	Red	450	600	-	mcd
				Green	1200	1400	-	
				Blue	200	400	-	
		-		1850	2400	-		
		$I_F = 60 \text{ mA}$ (R,G,B $I_F = 20 \text{ mA}$)						

* Tolerance : V_F ; $\pm 0.1V$, λ_D ; $\pm 2nm$, x,y : ± 0.02 , I_v ; $\pm 10\%$

* Luminous intensity measuring equipment : CAS140 B

4. Chromaticity Diagram

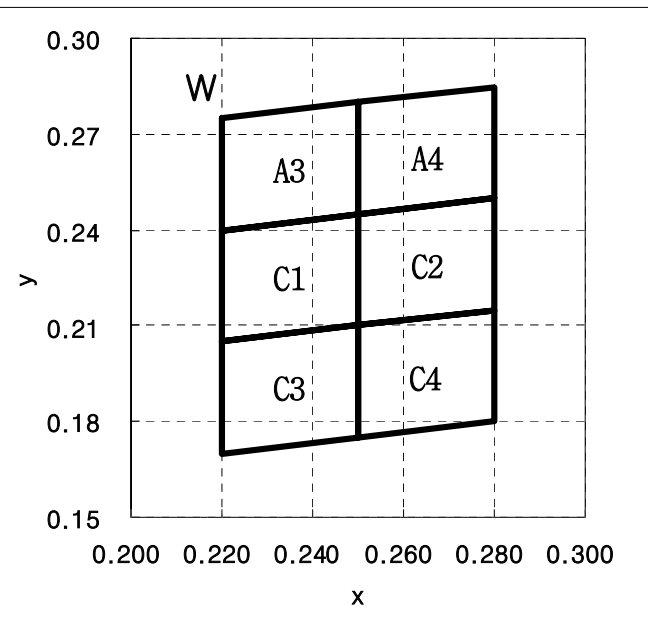
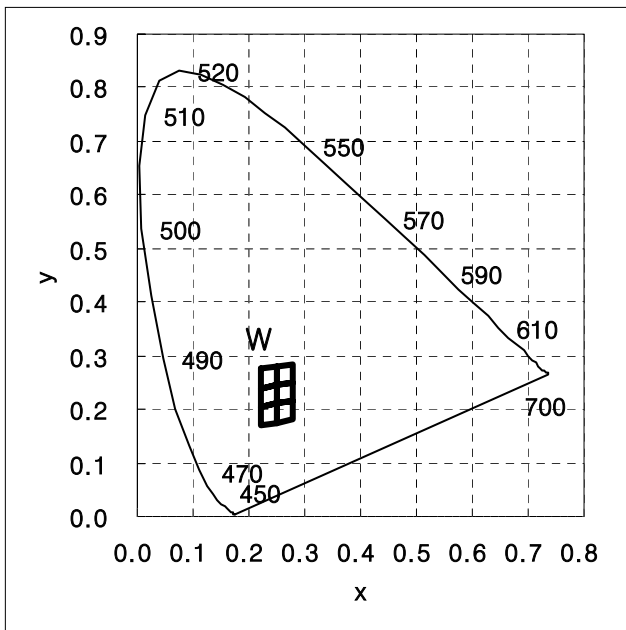

* $W = A3+A4+C1+C2+C3+C4$

※ Approved Rank

V_F	CIE	I_v
S	A3, A4 C1, C2, C3, C4	S

* Each reel contains only one of the A3, A4, C1, C2, C3 or C4, a segment (1/6) of the CIE rank.

5. Typical Characteristics Graph

* These graphs show typical values.

(Ta : 25°C)

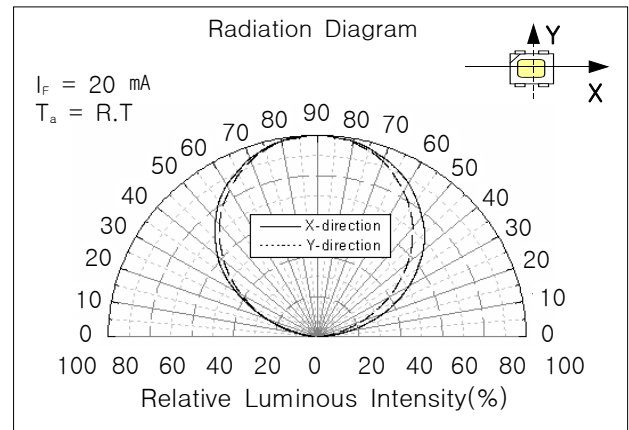
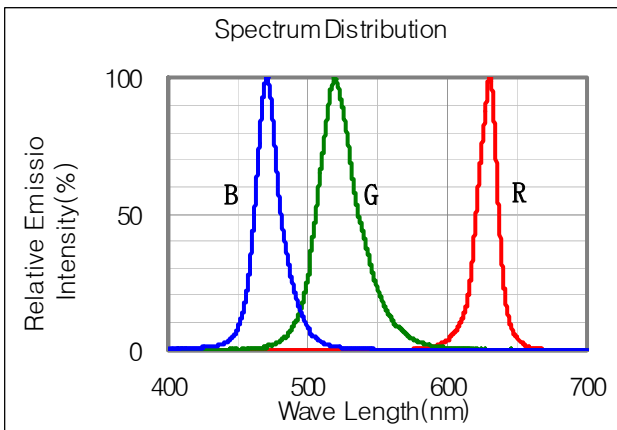
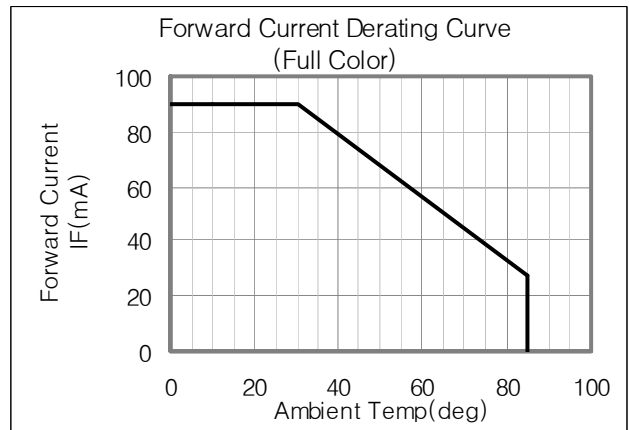
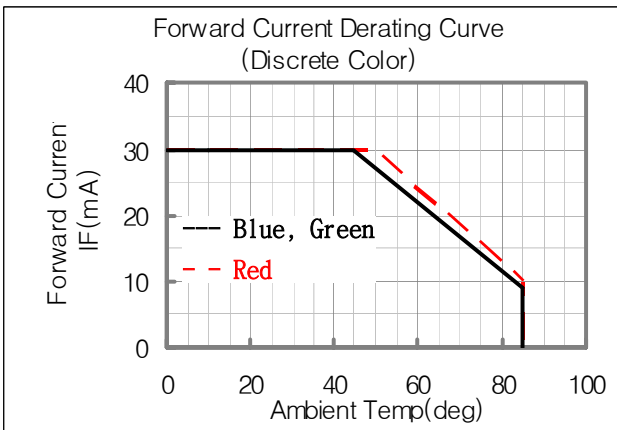
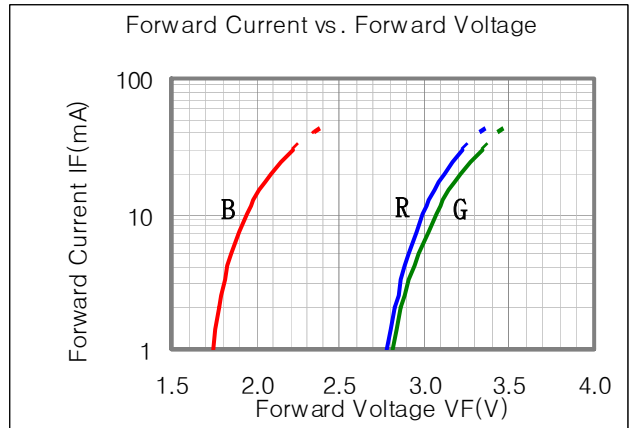
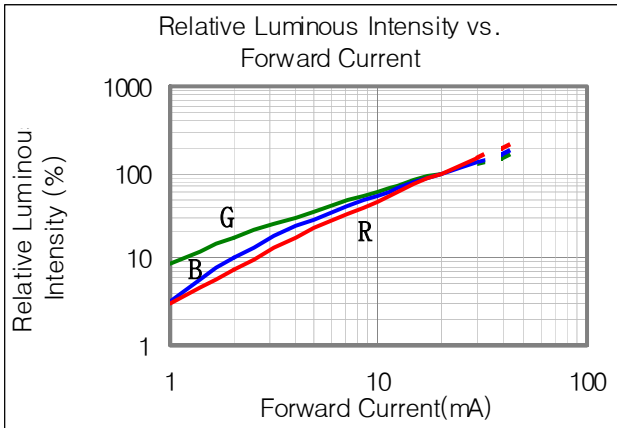

6. LED Package Outline Dimensions

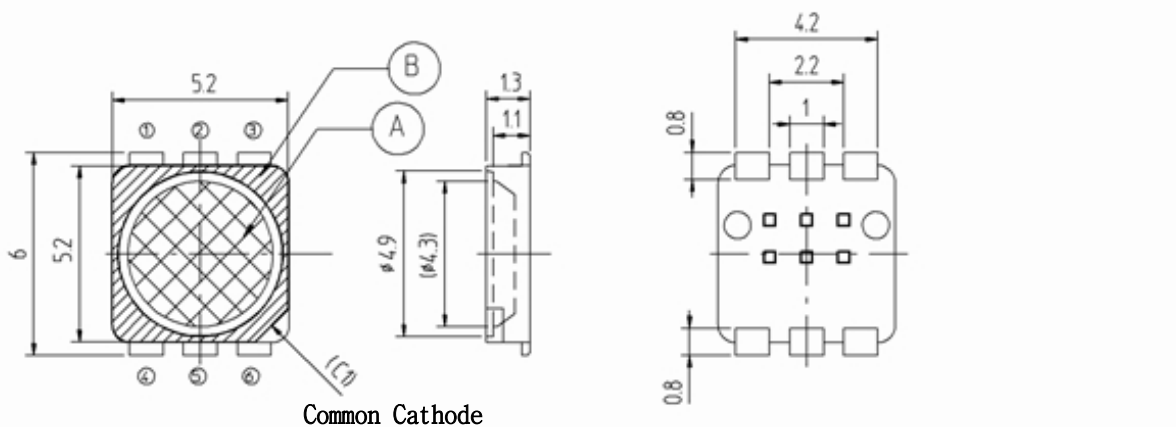

1. Tolerance is $\pm 0.1\text{mm}$.
2. Do not place pressure on the encapsulating resin ('A').
3. The maximum compressing force is 15N on the polymer ('B').

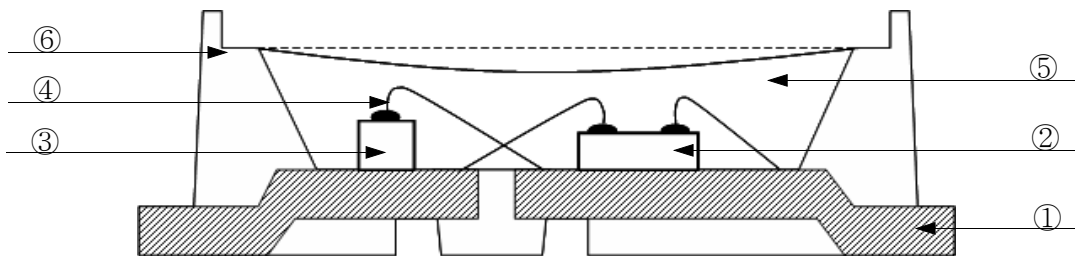
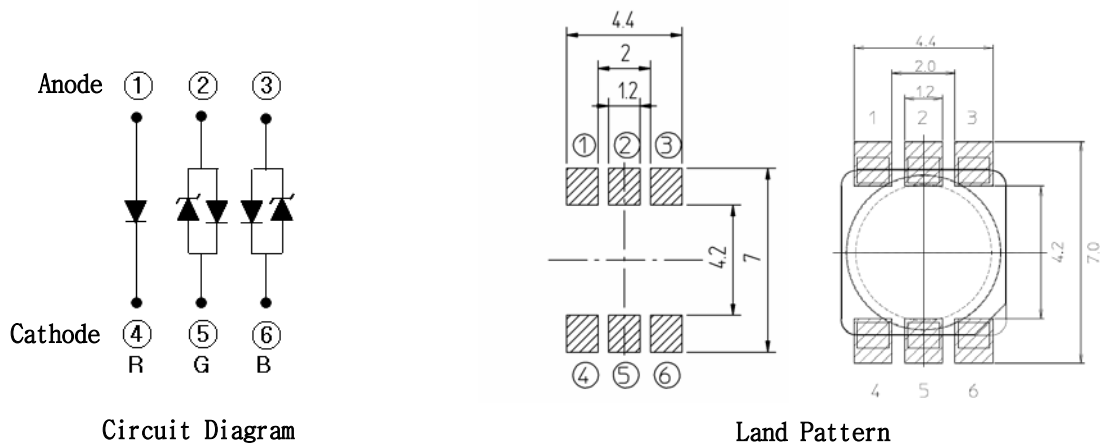

NUMBER	ITEM	MATERIAL
①	FRAME	Copper Frame(Silver Plated)
②	LED CHIP	AlGaInP, GaN/Al ₂ O ₃
③	Zener Diode	Si
④	WIRE	Gold Wire
⑤	RESIN	Resin
⑥	PACKAGE	Heat-resistant Polymer

7. Reliability Test Items and Conditions

1) Test Items and Results

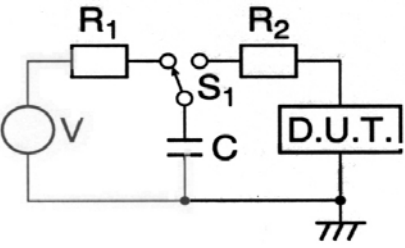
Test Item	Test Conditions	Test Hours/Cycles	Sample No
Room Temperature life test	25°C ± 3°C, Red;DC30 mA, Green;DC30 mA, Blue;DC30 mA	500 h	50
High Temperature humidity life test	60°C ± 3°C, 95% ± 2%RH, Red;DC18 mA, Green;DC18 mA, Blue;DC18 mA	500 h	50
High Temperature life test	85°C ± 3°C, Red;DC9 mA, Green;DC9 mA, Blue;DC9 mA	500 h	50
Low Temperature life test	-30°C ± 3°C, Red;DC30 mA, Green;DC30 mA, Blue;DC30 mA	500 h	50
Thermal Shock	-40°C ~ 100°C 0.5 h 0.5 h	100 cycles	22
High Temperature Storage	Ta=100°C ± 3°C	500 h	22
Low Temperature Storage	Ta=-40°C ± 3°C	500 h	22
High Temperature humidity Storage	60°C ± 3°C, 95% ± 2%RH	500 h	50
Temperature humidity Cycle	25°C ~ 65°C ~ -10°C 24hrs/1cycle, 95%RH	10 cycles	22
Reflow Soldeing (Pb-Free)	Peak 260 ± 5°C for 10sec, 220°C over time 60sec max	3 times	22
ESD(HBM)	 <p>-R1:10MΩ , R2:1.5KΩ , C:100pF</p>	5 times	5
On/Off test	50°C ± 3°C, 95% ± 2%RH, On/2sec, Off/2sec Red;DC30 mA, Green;DC30 mA, Blue;DC30 mA	120h	50

2) Criteria for Judging the Damage

Item	Symbol	Test Condition	Limit	
			Min	Max
Forward Voltage	V_F	$I_F=20 \text{ mA}$	-	U.S.L.*1.1
Luminous Intensity	IV	$I_F=20 \text{ mA}$	L.S.L.*0.5	-

* USL : Upper Standard Level LSL : Lower Standard Level

8. Solder Conditions

1) Reflow Conditions (Pb Free)

Reflow Frequency : 2 times max.

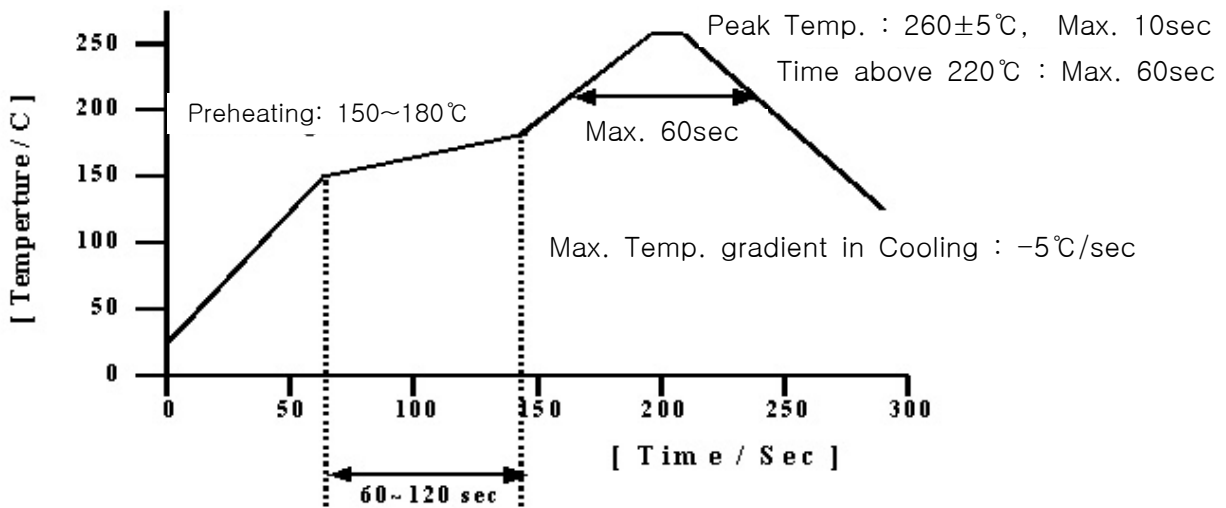

2) For Manual Soldering

Not more than 5 seconds @MAX300°C, under soldering iron.(one time only)

9. Taping Dimension

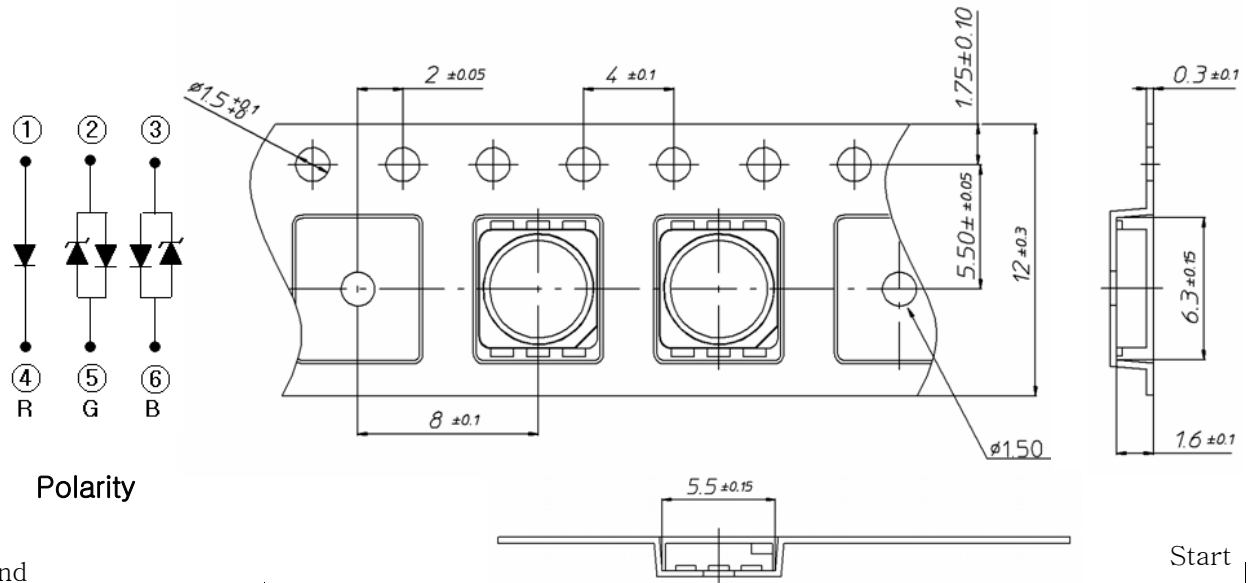

Polarity

End

Start

More than 40 mm
Unloaded tape

Mounted with
Flash LED

More than (100~200)mm
Unloaded tape

Leading part more than
(200~400)mm

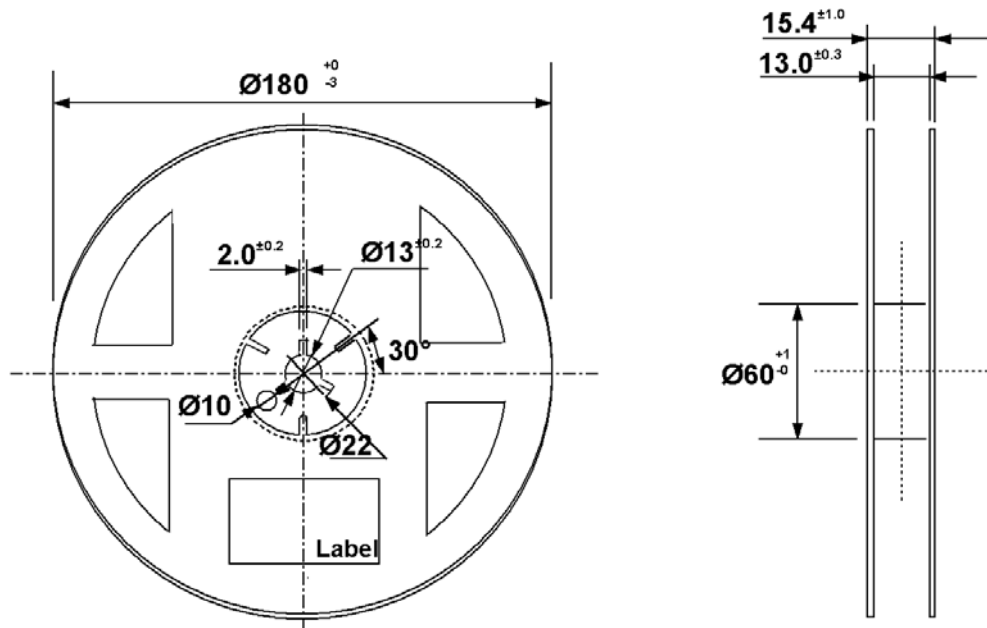

Tolerance ± 0.2 , Unit:mm

- (1) Quantity : The quantity/reel to be 1000pcs.
- (2) Cumulative Tolerance : Cumulative tolerance/10 pitches to be ± 0.2 mm
- (3) Adhesion Strength of Cover Tape : Adhesion strength to be 0.1–0.7N when the cover tape is turned off from the carrier tape at 10° angle to be the carrier tape.
- (4) Packaging : P/N, Manufacturing data code no. and quantity to be indicated on a damp proof package.

10. Label Structure

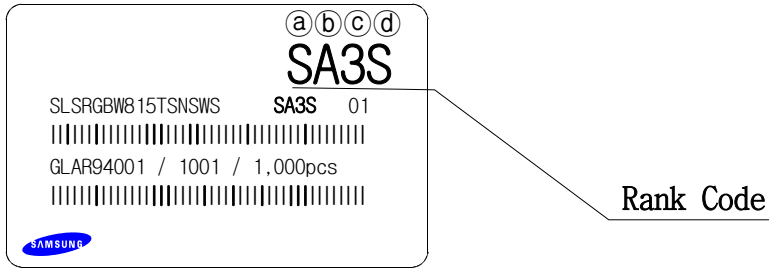

N.B) Denoted rank is the only example.

Rank Code

- (a) : Forward Voltage(V_F) Rank (refer to page. 3)
- (b)(c) : Chromaticity Coordinate Rank (refer to page. 4)
- (d) : Luminous Intensity(I_v) Rank (refer to page. 4)

11. Lot Number

The Lot number is composed of the following characters

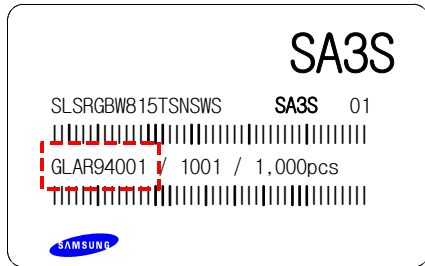

●◎◇◆□■△△△ / |▲▲▲ / 1000PCS

● : Production Site (S:SEMCO, G:Gosin China)

◎ : L (LED)

◇ : Product State (A:Normality, B: Bulk, C:First Production, R:reproduction, S:Sample)

◆ : Year (Q:2006, R:2007, S:2008...)

□ : Month (1 ~ 9, A, B)

■ : Day (1 ~ 9, A, B ~ V)

△ : SEMCO. Product number (1 ~ 999)

▲ : Reel Number (1 ~ 999)

12. Reel Packing Structure

Reel

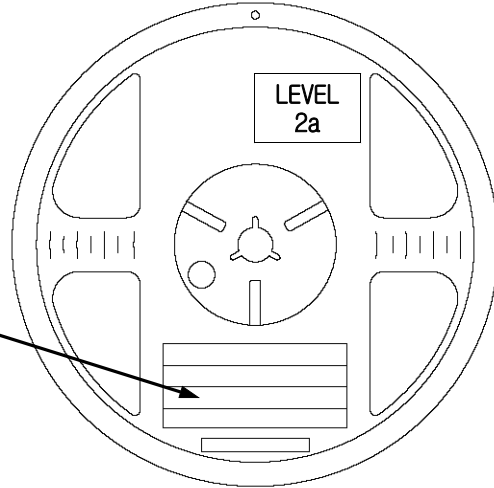
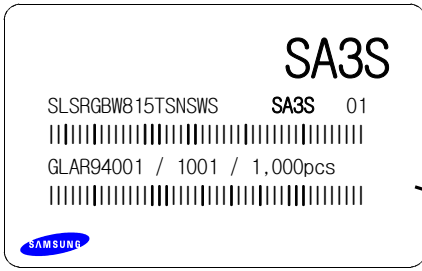

Aluminum Vinyl Bag

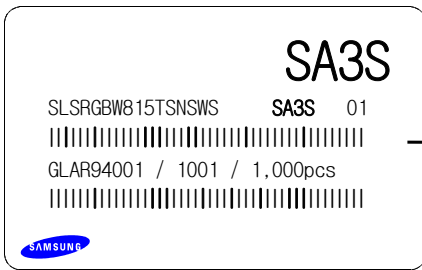

Material : Paper(SW3B(B))

TYPE	SIZE(mm)		
	L	W	H
7inch	245	220	182

① SIDE

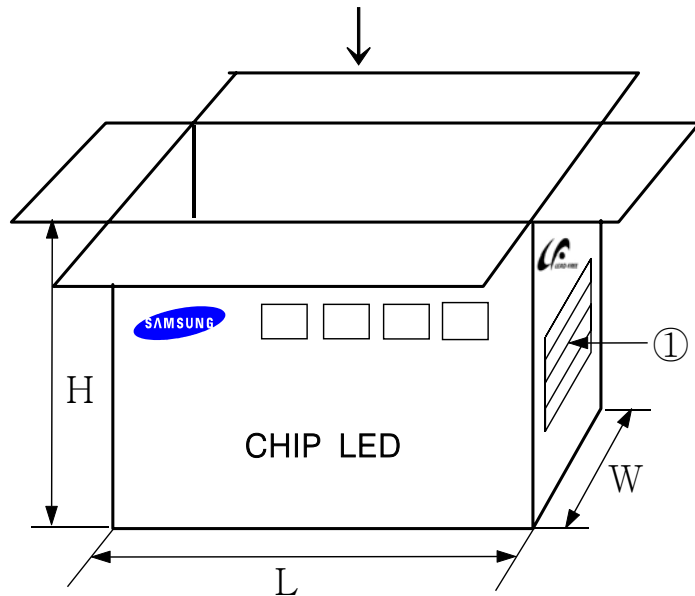
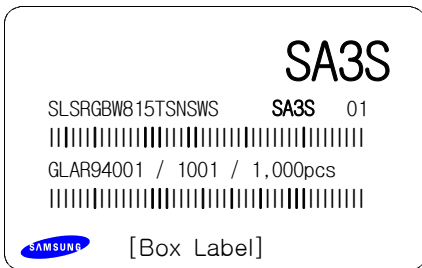

13. Aluminum Vinyl Bag



CAUTION

This bag contains
MOISTURE SENSITIVE DEVICES

LEVEL

2a

1. Shelf life in sealed bag: 12 months at 40°C and 90% relative humidity (RH)
2. Peak package body temperature: 240°C
3. After this bag is opened, devices that will be subjected to reflow solder or other high temperature processes must be:
 - a. Mounted within 672 hours at factory conditions of equal to or less than 30°C / 60% RH, or
 - b. Stored at 10% RH
4. Devices require bake, before mounting, if:
 - a. Humidity Indicator Card is > 65% when read at $23 \pm 5^{\circ}\text{C}$, or
 - b. 2a is not met.
5. If baking is required, devices must be baked for 1 hours at $60 \pm 5^{\circ}\text{C}$

Note: if device containers cannot be subjected to high temperature or shorter bake times are desired, reference IPC/JEDEC J-STD-033 for bake procedure,

Bag seal due date: _____
(if blank, see code label)

Note: Level and body temperature by IPC/JEDEC J-STD-020

SA3S

SLSRGBW815TSNSWS SA3S 01

|||||

GLAR94001 / 1001 / 1,000pcs

|||||

SAMSUNG



LEAD-FREE





ATTENTION
OBSERVE PRECAUTIONS
FOR HANDLING
ELECTROSTATIC
SENSITIVE
DEVICES



OTHER

주의 사항

이 알루미늄 지퍼 백은 습기 및 정전기로부터 제품을 보호하기 위하여 제작되었습니다. 개봉 후에는 즉시 솔더 작업을 실시하는 것을 권장합니다.

습기 및 정전기로부터 제품을 보호 하기 위해서 개봉 후 사용하지 않는 자재는 본 팩에 넣어 보관 하시기 바랍니다. 사용하지 않는 자재를 본 팩에 넣을 때는 반드시 동봉된 드라이 팩과 함께 넣고 지퍼부분을 완전하게 밀봉하여 주시기 바랍니다.

Important

This Al Zipper bag is designed to protect the enclosed products from moisture and ESD. Once opened, the products should be soldered onto the printed circuit board immediately. When not in use, please do not leave the products unprotected by the Al Zipper Bag. To repack unused products., please ensure the zip-lock is completely sealed with the dry pack left inside.

Silica gel & Humidity Indicator Card in Aluminum Vinyl Bag



14. Precaution for Use

- 1) For over-current-proof function, customers are recommended to apply resistors to prevent sudden change of the current caused by slight shift of the voltage.
電圧の少しの変更により引き起こされる突然の電流変更を防ぐために過電流防止機能の抵抗器を適用する ように勧めします。
- 2) This device should not be used in any type of fluid such as water, oil, organic solvent, etc. When washing is required, IPA is recommended to use.
本製品は、水、油、有機的な溶剤などの任意のタイプの流体の中で使用しないで下さい。
洗浄が要求される場合、IPAを使用して下さい。
- 3) When the LEDs illuminate, operating current should be decided after considering the ambient maximum temperature.
LED発光の時、動作電流はLED周囲の温度条件により使用電流を決めてください。
- 4) LEDs must be stored in a clean environment.
If the LEDs are to be stored for 3 months or more after being shipped from SEMCO, they should be packed by a sealed container with nitrogen gas injected.
(Shelf life of sealed bags: 12 months, temp. 0~40°C, 20~70%RH)
本製品は清潔な大気を維持する環境で保存して下さい。
LEDが送られた後に3か月以上保存される場合、窒素雰囲気を用意した密封したコンテナ装置に保管して下さい。(0~40°C以下、20~70%のRH以下とし12か月以内)
- 5) After storage bag is open, device subjected to soldering, solder reflow, or other high temperature processes must be:
 - a. Mounted within 168 hours (7 days) at an assembly line with a condition of no more than 30°C/60%RH,
 - b. Stored at <10% RH開封後、Reflowハンダあるいは他の高温プロセスにさらされる場合は、
 - a. 工場条件30°C以下、60%RH以下の条件で168時間（7日）以内にマウントを完了して下さい。
 - b. また10%のRHで保存して下さい。
- 6) Repack unused Products with anti-moisture packing, fold to close any opening and then store in a dry place.
未使用のLEDが残った場合は、乾燥剤（シリカゲル）入り乾燥容器などで保管して下さい。
なお当社防湿袋に戻し、再封印することを推奨します。

7) Devices require baking before mounting, if humidity card reading is $>65\%$ at $23\pm 5^{\circ}\text{C}$.

以下の場合、マウントする前にbakeすることをお勧めします。

$23\pm 5^{\circ}\text{C}$ での湿度カードの表紙が65%以上の時

8) Devices must be baked for 24hours at $65\pm 5^{\circ}\text{C}$, if baking is required.

Bakingが要求される場合、 $65\pm 5^{\circ}\text{C}$ で24時間Bakeすることをお勧めします。

9) The LEDs are sensitive to the static electricity and surge. It is recommended to use a wrist band or anti-electrostatic glove when handling the LEDs.

If voltage exceeding the absolute maximum rating is applied to LEDs, it may cause damage or even destruction to LED devices.

Damaged LEDs may show some unusual characteristics such as increase in leak current, lowered turn-on voltage, or abnormal lighting of LEDs at low current.

本製品は静電気やサージ電圧に敏感で、素子の損傷や信頼性低下を起こすことがあります。本LEDの取り扱いに際しては、手首バンドまたは静電気防止グローブ等の静電気対策を十分行って下さい。

LEDに最大定格電圧値を超過される場合、LEDの損害を引き起こし、破壊する可能性があります。

損傷したLEDには、漏洩電流が著しく大きくなり、順方向の立ち上がり電圧が低下したり低電流で発光しなくなる等の異常が現れます。

15. Hazard Substance Analysis



Test Report No. F690501/LF-CTSAYA07-08113

Date: April 03, 2007

Page 1 of 3

To: **SAMSUNG ELECTRO-MECHANICS CO., LTD.**
314, Maetan3-dong
Yeongtong-gu
Suwon-city
GYEONGGI-DO 442-373
Korea

The following merchandise was submitted and identified by the client as :

Product Name : 5252 Full Color LED
SGS File No. : AYA07-08113
Received Date : March 28, 2007
Test Performing Date : March 29, 2007
Test Performed : SGS Testing Korea tested the sample(s) selected by applicant with following results
Test Results : For further details, please refer to following page(s)

Pluto Kim
Monet Jeong
Jully Oh
Jerry Jung
/Testing Person

SGS Testing Korea Co. Ltd.

Jeff Jang / Chemical Lab Mgr

This document is issued by the Company under its General Conditions of Service accessible at http://www.sgs.com/terms_and_conditions.htm. Attention is drawn to the limitation of liability, indemnification and jurisdiction issues defined therein. Any other holder of this document is advised that information contained hereon reflects the Company's findings at the time of its intervention only and within the limits of Client's instructions, if any. The Company's sole responsibility is to its Client and this document does not exonerate parties to a transaction from exercising all their rights and obligations under the transaction documents. Any unauthorized alteration, forgery or falsification of the content or appearance of this document is unlawful and offenders may be prosecuted to the fullest extent of the law.

SGS Testing Korea Co., Ltd. 322, The O valley, 555-9, Hoge-dong, Dongan-gu, Anyang-si, Gyeonggi-do, Korea 431-080
t +82 (0)31 4608 000 f +82 (0)31 4608 059 www.sgslab.co.kr, www.kr.sgs.com/greenlab
1002-2, Hwasan-ri, Onsan-eub, Uiju-gun, Ulsan, Korea 689-890 t +82 (0)52 239 6908-10 f +82 (0)52 239 6913



Test Report No. F890501LP-GTSAYA07-08113

Date: April 03, 2007

Page 2 of 3

Sample No. : AYA07-08113.001
 Sample Description : 5252 Full Color LED
 Item No./Part No. : N/A

Heavy Metals

Test Item	Unit	Test Method	MDL	Results
Cadmium (Cd)	mg/kg	US EPA 3050B(1995), US EPA 8010B(1995), ICP	0.5	N.D.
Lead (Pb)	mg/kg	US EPA 3050B(1995), US EPA 8010B(1995), ICP	5	N.D.
Mercury (Hg)	mg/kg	US EPA 3052(1995), US EPA 8010B(1995), ICP	2	N.D.
Hexavalent Chromium (Cr VI)	mg/kg	US EPA 3060A(1995), US EPA 7195A(1992), UV	1	N.D.

Flame Retardants-PPRS/BBR/Es

Test Item	Unit	Test Method	MDL	Results
Monobromodiphenyl	mg/kg	US EPA 3540C, GC/MS	5	N.D.
Dibromodiphenyl	mg/kg	US EPA 3540C, GC/MS	5	N.D.
Tri bromodiphenyl	mg/kg	US EPA 3540C, GC/MS	5	N.D.
Tetrabromodiphenyl	mg/kg	US EPA 3540C, GC/MS	5	N.D.
Pentabromodiphenyl	mg/kg	US EPA 3540C, GC/MS	5	N.D.
Hexabromodiphenyl	mg/kg	US EPA 3540C, GC/MS	5	N.D.
Heptabromodiphenyl	mg/kg	US EPA 3540C, GC/MS	5	N.D.
Octabromodiphenyl	mg/kg	US EPA 3540C, GC/MS	5	N.D.
Nonabromodiphenyl	mg/kg	US EPA 3540C, GC/MS	5	N.D.
Decabromodiphenyl	mg/kg	US EPA 3540C, GC/MS	5	N.D.
Monobromodiphenyl ether	mg/kg	US EPA 3540C, GC/MS	5	N.D.
Dibromodiphenyl ether	mg/kg	US EPA 3540C, GC/MS	5	N.D.
Tri bromodiphenyl ether	mg/kg	US EPA 3540C, GC/MS	5	N.D.
Tetrabromodiphenyl ether	mg/kg	US EPA 3540C, GC/MS	5	N.D.
Pentabromodiphenyl ether	mg/kg	US EPA 3540C, GC/MS	5	N.D.
Hexabromodiphenyl ether	mg/kg	US EPA 3540C, GC/MS	5	N.D.
Heptabromodiphenyl ether	mg/kg	US EPA 3540C, GC/MS	5	N.D.
Octabromodiphenyl ether	mg/kg	US EPA 3540C, GC/MS	5	N.D.
Nonabromodiphenyl ether	mg/kg	US EPA 3540C, GC/MS	5	N.D.
Decabromodiphenyl ether	mg/kg	US EPA 3540C, GC/MS	5	N.D.

- NOTE: (1) N.D. = Not detected.(<MDL)
 (2) ppm = mg/kg
 (3) MDL = Method Detection Limit
 (4) - = No regulation
 (5) * = Qualitative analysis (No Unit)
 (6) Negative = Undetectable / Positive = Detectable

This document is issued by the Company under its General Conditions of Service available at http://www.sgs.com/terms_and_conditions. His attention is drawn to the limitation of liability, indemnification and jurisdiction issues defined therein. Any other holder of this document is advised that information contained herein reflects the Company's findings at the time of its intervention only and within the limits of Client's instructions, if any. The Company's sole responsibility is to its Client and this document does not exonerate parties to a transaction from exercising all their rights and obligations under the transaction documents. Any unauthorized alteration, forgery or falsification of the content or appearance of this document is unlawful and offenders may be prosecuted to the fullest extent of the law.



Test Report No. F690501/LF-CTSAYA07-08113

Date: April 03, 2007

Page 3 of 3

Picture of Sample as Received:

Sample Color :

White

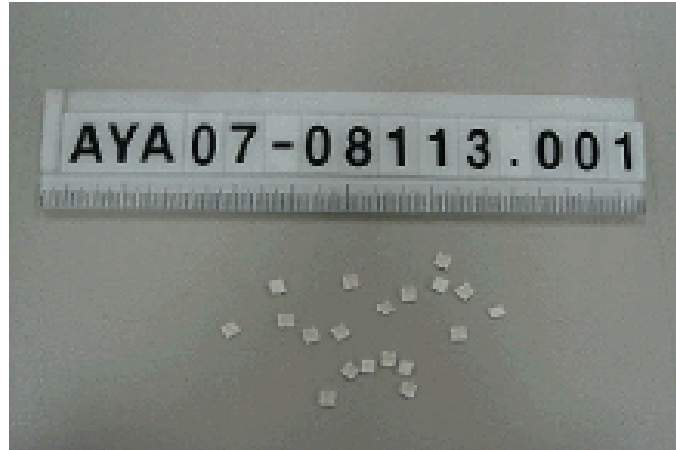

*** End ***

- NOTE: (1) N.D. = Not detected (-MDL)
(2) ppm = mg/kg
(3) MDL = Method Detection Limit
(4) - = No regulation
(5) ** = Qualitative analysis (No Unit)
(6) Negative = Undetectable / Positive = Detectable

This document is issued by the Company under its General Conditions of Service accessible at http://www.sgs.com/terms_and_conditions. His attention is drawn to the limitation of liability, indemnification and jurisdiction issues defined therein. Any other holder of this document is advised that information contained herein reflects the Company's findings at the date of its intervention only and within the limits of Client's instructions, if any. The Company's sole responsibility is to its Client and this document does not exonerate parties to a transaction from exercising all their rights and obligations under the transaction documents. Any unauthorized alteration, forgery or falsification of the content or appearance of this document is unlawful and offenders may be prosecuted to the fullest extent of the law.